

OWNER'S MANUAL

AH673/44 TUNER

PHILIPS HIGH FIDELITY LABORATORIES SERIES

PHILIPS HIGH FIDELITY LABORATORIES Series

673



EQUAL



TUNING

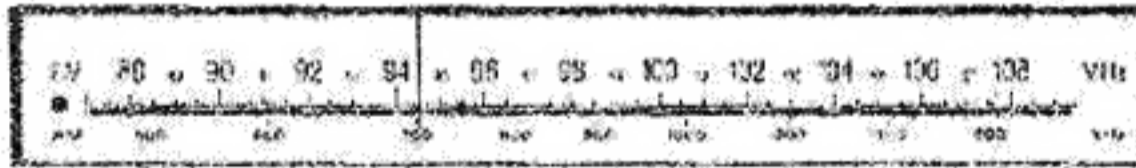

AM

FM

STEREO

WIDE

MONO



PHILIPS

INTRODUCTION

You are now the proud owner of one of the finest tuners on the market; the Philips Model 673. This high quality instrument incorporates state of the art design technology and components to give you many years of outstanding performance and trouble free operation.

The front panel layout is simple and straight forward using a combination of precision rotary controls and touch switches with LED (Lighting Emitting Diode) indicators. The touch switches provide smooth silent operation without the "pops" and "clicks" of mechanical switches. The LED indicator located above each set of touch contacts tells you at a glance which switches have been activated. Two separate adjustments for AM and FM output level provide you with the ultimate in flexibility and performance. These variable linear controls allow adjustment from 0 - 1 volt for each output.

The wide view dial scale features finely etched, precision graphics. The fine resolution, large viewing length and balanced graduations along with a high momentum flywheel provide for easy viewing and a smooth, positive tuning characteristic.

Two tuning meters have been provided as additional tuning aids. The use of independent center-tune and signal strength meters enables you to tune in a station quickly and accurately. At a touch of the finger, the center-tune meter becomes a multipath meter. The multipath meter in conjunction with the signal strength meter allows you to independently observe optimum signal strength and minimum multipath. This will permit adjustment of antenna orientation for optimum signal reception. In addition to this convenient two meter approach, horizontal and vertical outputs are available on the rear panel for oscilloscope viewing of multipath.

Full fidelity AM has been incorporated into this tuner for performance and response on the AM Band approaching a quality once thought possible only through FM transmission. It has often been assumed that the fidelity of AM would be poor at best, but in fact, AM is capable of very good fidelity, wide range response and low distortion. Also incorporated is a 10 KHz sharp notch filter which, when activated, considerably reduces any adjacent channel 10 KHz heterodyne whistle when listening to AM broadcasts. Touch the Automatic Stereo Noise Cancelling Switch, ASNC, and it activates a unique circuit which virtually eliminates the annoyance of noisy FM stereo broadcasts and provides clear reception of marginally weak FM stereo stations.

The Model and Serial Number of your Philips High Fidelity Laboratories tuner will be found on the rear or bottom of the instrument. Please record this Model and Serial Number in the space provided below.

Model Number _____ Serial Number _____

WARNING — TO PREVENT DAMAGE WHICH MAY RESULT IN FIRE OR SHOCK HAZARD, DO NOT EXPOSE THIS APPLIANCE TO RAIN OR EXCESSIVE MOISTURE.

INSTALLATION

LOCATION

The tuner should be placed as close to your other components as is convenient. Do not locate the tuner in direct sunlight, near radiators or other sources of heat. Locations having high humidity or excessive dust should be avoided if at all possible. If you plan to install the tuner in any type of cabinet or enclosure, be sure to allow for adequate ventilation. To ensure best performance, take the time to prepare a location that is sturdy enough to support the tuner and its associated components.

ADDITIONAL EQUIPMENT

Any additional audio equipment that you may wish to purchase should be of the same high quality as this tuner. The Philips 673 is compatible with other products from Philips High Fidelity Laboratories as well as most other high quality component equipment.

TUNER CONNECTION

AMPLIFIER

Two pairs of audio output terminals, variable and fixed, are provided on the rear of the tuner. Connect the variable output terminals to the Tuner or Aux inputs of the amplifier using the audio cable which is supplied. The signal level from the variable terminals is controlled by the two level controls on the front of the tuner. The Fixed output terminals may be connected to the Line Input terminals of a tape deck. Since the signal level from the Fixed output terminals cannot be adjusted at the tuner, this must be done with the record level controls of the tape deck.

MULTIPATH

The Multipath terminals may be connected to the horizontal and vertical inputs of an oscilloscope for the purpose of visually monitoring multipath distortion. This can aid you in positioning the FM antenna for minimum multipath and maximum signal strength. When operating the oscilloscope, follow the instruction manual supplied with it.

FM DETECTOR OUTPUT

An FM detector output is available on the back panel, ready for use when Quad 4 channel FM is perfected.

FM ANTENNA

A folded dipole FM antenna has been provided with this tuner. To connect this antenna, loosen the two 300 ohm antenna screws, slip the "u" shaped lugs of the antenna under the screws and tighten them securely. The crossbar of the antenna should be mounted flat and horizontally on the wall, along the back edge of a shelf or other convenient location. This antenna is directional; therefore, selecting the best location may require some experimentation. Although this antenna should be adequate for reception of local stations, you may wish to install an outdoor FM antenna.

Terminals have been provided for the connection of 75 ohm cable. This type of antenna cable may be connected by stripping the insulation from one end

and installing the cable as shown in the illustration. It may also be connected to the tuner by first installing an F type screw-on connector on the end of the cable and then attaching the cable to the 75 ohm connector of the tuner as shown in the connection diagram.

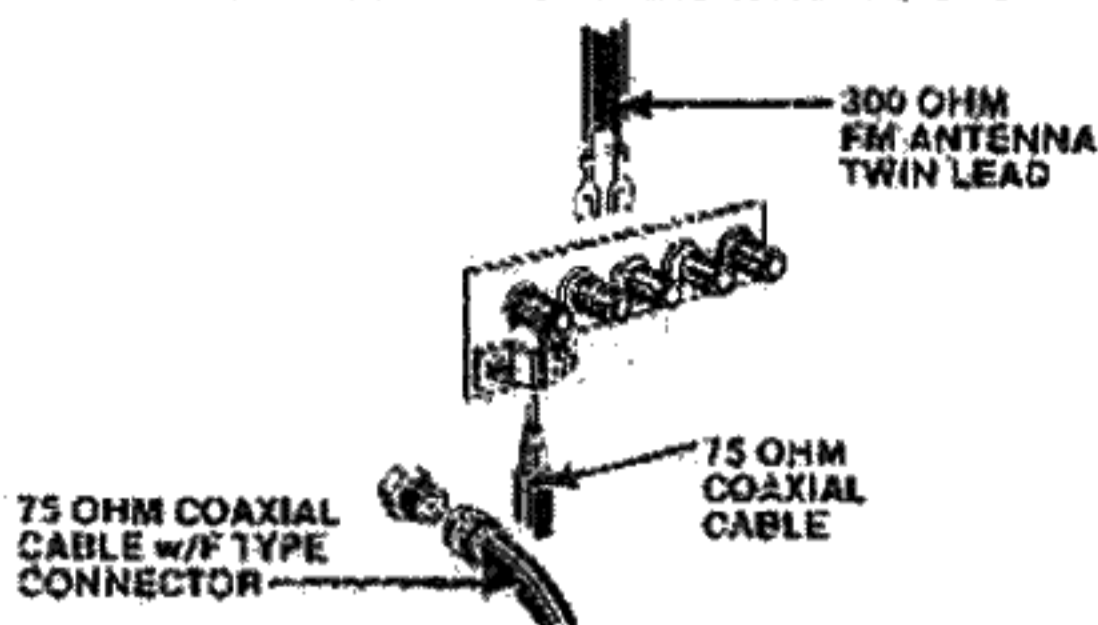

When you install an outdoor antenna, it should be oriented to provide maximum signal strength and minimum reflections. The antenna should be as far away from roads and streets as possible since passing cars and trucks can cause reflections. By using the signal strength and multipath meters, the correct antenna position is indicated by maximum deflection of the signal strength meter and minimum deflection of the multipath meter.

AM ANTENNA

The bar antenna mounted on the back of the tuner will provide satisfactory reception of local stations. The 3-dimensional mounting allows you to position the antenna to eliminate interference and increase the signal strength.



If you live in an area where satisfactory reception cannot be obtained by using the bar antenna, an outdoor AM antenna should be connected to the AM terminal of the tuner. **NOTE: All wires and cables should be routed away from the AM antenna since it is possible for these wires to introduce feedback into the tuner through the antenna.**

CONTROLS

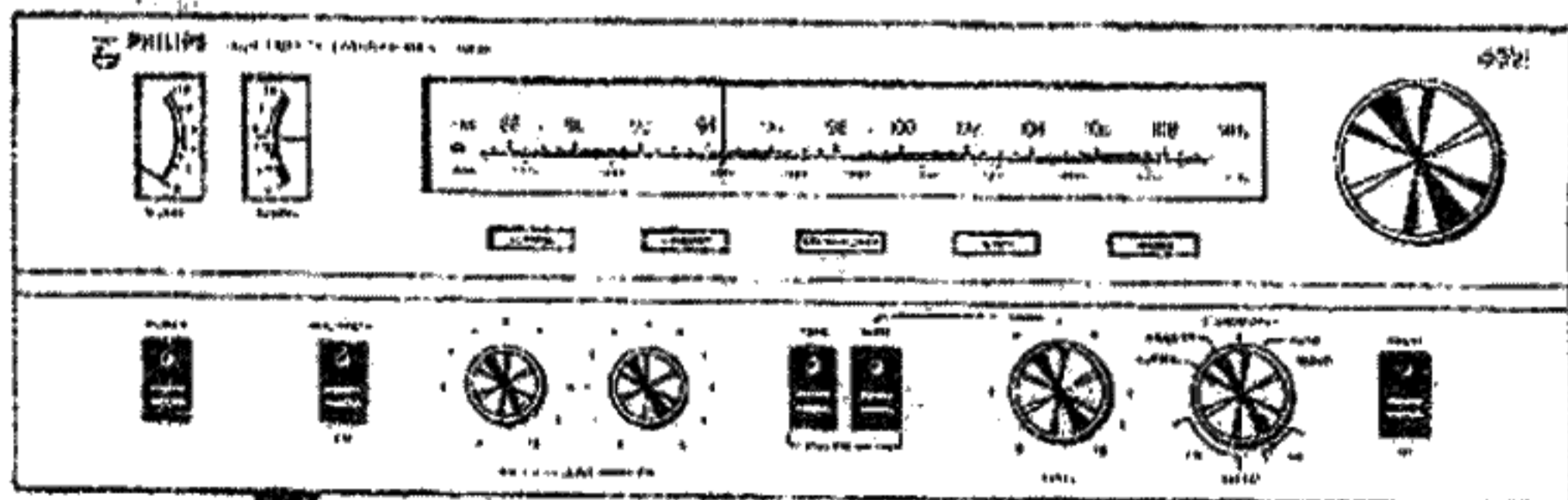

MASTER POWER

The Master Power switch, located on the back panel of the tuner, controls the power for all of the circuits except the unswitched AC receptacle. This switch must be in the On position for the tuner to operate. If the tuner is not used for an extended period of time, such as when you are on vacation, place the Master Power switch in the Off position.

POWER

After placing the Master Power switch in the On position, the Power touch switch on the front panel is used to turn the tuner On and Off. The LED indicator above the touch contacts will be lit when the power is on.

FM MULTIPATH

Activating the Multipath switch converts the tuning meter from a center-tuning meter to a multipath meter for monitoring multipath distortion. This enables you to adjust the antenna for minimum multipath.

AM/FM LEVEL

The separate Level controls allow you to independently adjust the audio output for AM and FM. These continuously variable, linear controls provide adjustments of 0 to 1 volt for each output and enable you to balance the volume level of the tuner with your other components.

ASNC

The Automatic Stereo Noise Cancelling (ASNC) circuit can be activated when listening to a noisy FM stereo broadcast. This unique circuit senses the amount of noise in the broadcast; if the noise rises above a given threshold, a Schmitt trigger and a switching transistor activate the noise cancelling circuit to provide clear reception of marginally weak stereo stations. **NOTE: When the ASNC circuit is in operation, it reduces noise on weak stereo stations without reducing separation on strong stereo stations.**

MUTE

The Mute switch is used in conjunction with the Mute Level control to eliminate interstation noise as well as weak stations. The threshold at which muting takes place is adjusted with the Mute Level control which is located to the right of the Mute switch. Minimum muting action occurs with the Level control placed fully counterclockwise and maximum muting occurs at the fully clockwise position.

SELECT SWITCH

The Select switch is used to select the different operational modes as follows:

- NORMAL— for reception of AM broadcasts.
- FIDELITY— for reception of AM broadcasts in Full Fidelity. Most people assume that AM fidelity will be poor at best and, therefore, not worthy of their attention. The medium of AM is, in fact, capable of very good fidelity; much better than is usually thought. Philips' Full Fidelity AM circuits provide a frequency response approaching that of FM; typically 20 Hz - 10 KHz \pm 2db with distortion factor of .5% @ 30% modulation and 1.5% @ 90% modulation.
- STEREO ONLY— Permits reception of only those FM stations which are broadcasting in stereo. In addition, interstation noise is automatically muted.
- AUTO— Allows reception of stereophonic FM and monophonic FM broadcasts. A stereo broadcast is indicated by the illumination of the stereo indicator light located to the left of the dial scale.
- MONO— In this position all FM broadcasts are reproduced monophonically.

AM 10 KHz SWITCH

When the 10 KHz switch is activated, a sharp notch bridge T - LC filter is introduced into the IF circuit to eliminate adjacent channel 10 KHz heterodyne whistle.

TUNING

The Tuning knob is used to tune in the desired AM or FM station.

SIGNAL STRENGTH METER

The Signal Strength meter indicates the relative strength of the station being received. This meter will also assist you in properly orienting the antenna for maximum signal strength.

CENTER/MULTIPATH METER

This meter is used for precisely tuning to the center frequency of an AM or FM radio station. Turn the tuning knob until the needle is at the center of the scale.

This meter also functions as a multipath meter on FM by activating the Multipath switch. Using the Multipath meter, adjust the antenna for minimum deflection of the needle.

OPERATION

Before operating the tuner, check to make sure that all connections have been properly made and that power is supplied to all of the equipment.

FM RECEPTION

1. Place the Master Power switch in the On position. Turn the tuner on by activating the Power switch on the front panel.
2. Place the Select switch in the Auto position
3. Turn the Mute off. After you become accustomed to operating the tuner you may wish to eliminate the interstation noise. To do this, activate the Mute switch and turn the Mute level clockwise until the interstation noise is eliminated. As the Level control is turned further clockwise, weak stations will also be muted.
4. Rotate the Tuning knob to locate the desired station. Once the station is found, observe the signal meter and adjust the tuning knob for maximum deflection of the needle of the meter. Complete the tuning by observing the Center-tune meter and adjust the Tuning knob until the needle is centered.
5. Adjust the FM Level control for a useful level.

AM RECEPTION

1. Turn on Tuner.
2. Place the Select switch in the Normal or Fidelity position.
3. Select the desired station in the same manner as you would select an FM station.
4. Adjust the AM Level control for a useful level.

TYPICAL SYSTEM CONNECTIONS

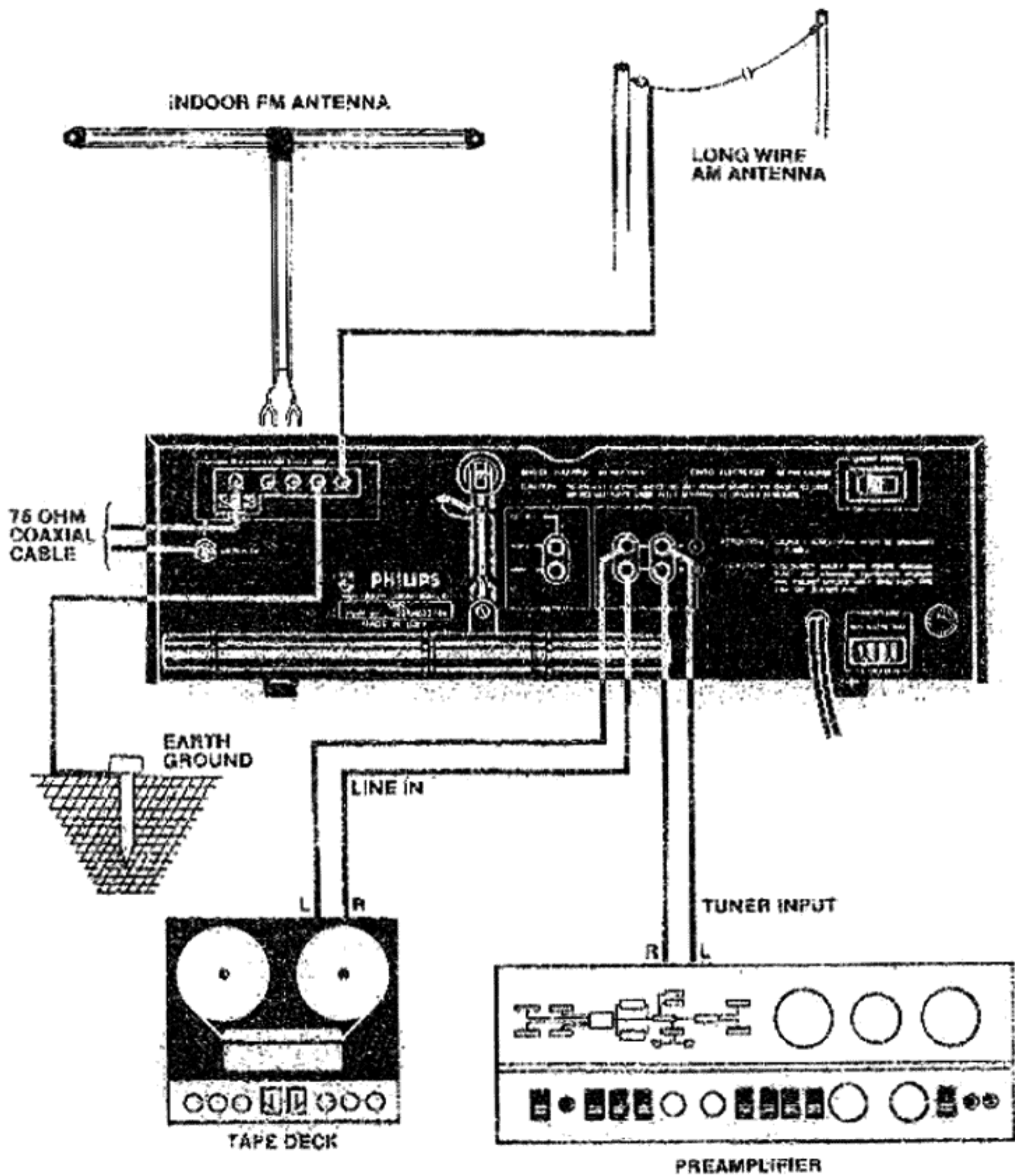

MAINTENANCE

If the tuner fails to operate, check to be sure that the Master Power switch is in the On position and that the tuner is connected to an active outlet supplying 120 volts, 60 Hz AC. If, after making these checks, the tuner still does not operate; disconnect the line cord from the electrical outlet and check the fuse located on the back panel. If the fuse is blown, replace only with a .5 amp, 125 volt slow-blow fuse. Plug the tuner in and turn it on. **Caution: If the tuner fails to operate or the fuse blows again after a short time, do not attempt to replace the fuse again. Disconnect the line cord and contact your dealer or a qualified serviceman. Any attempt to replace the fuse with one of a different value may constitute a fire hazard.**

CONTROL PANEL

To clean the control panel, disconnect the AC line cord from the electrical outlet and use a clean lint-free cloth moistened with warm water only. Remove any excess water before plugging the tuner in.

LAMPS AND INDICATORS

Should any of the control panel lamps or function indicators burn out, do not attempt to replace them yourself. Refer servicing to a qualified serviceman.

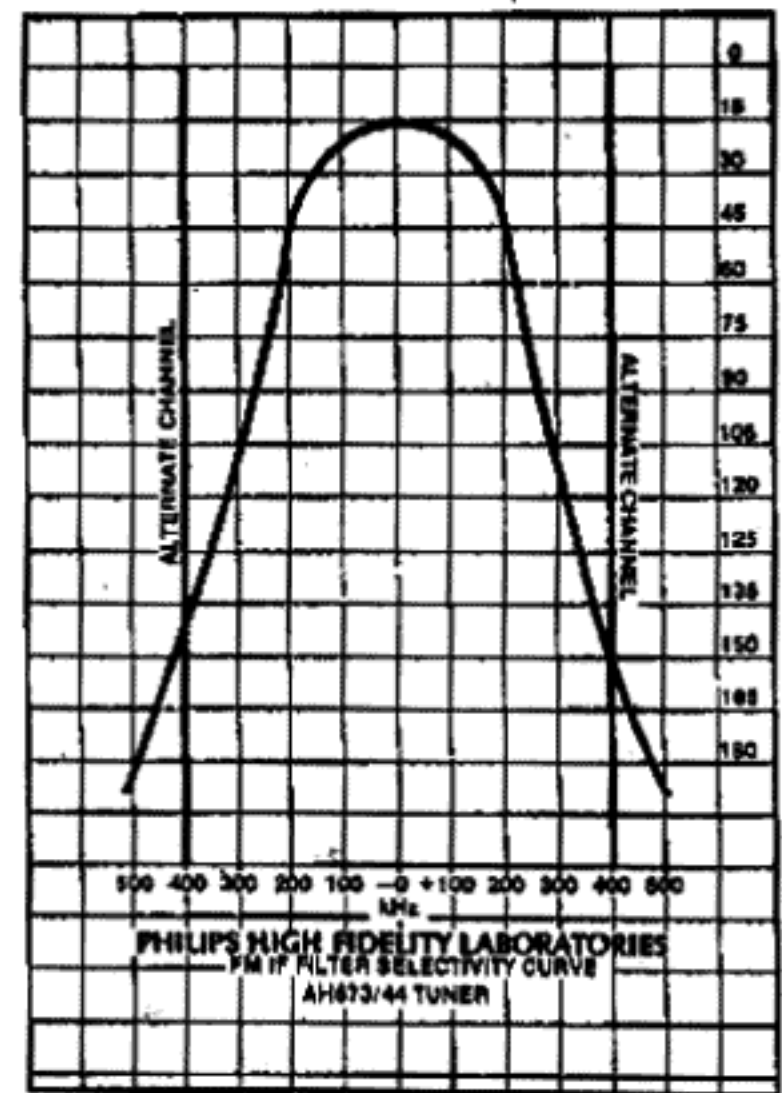
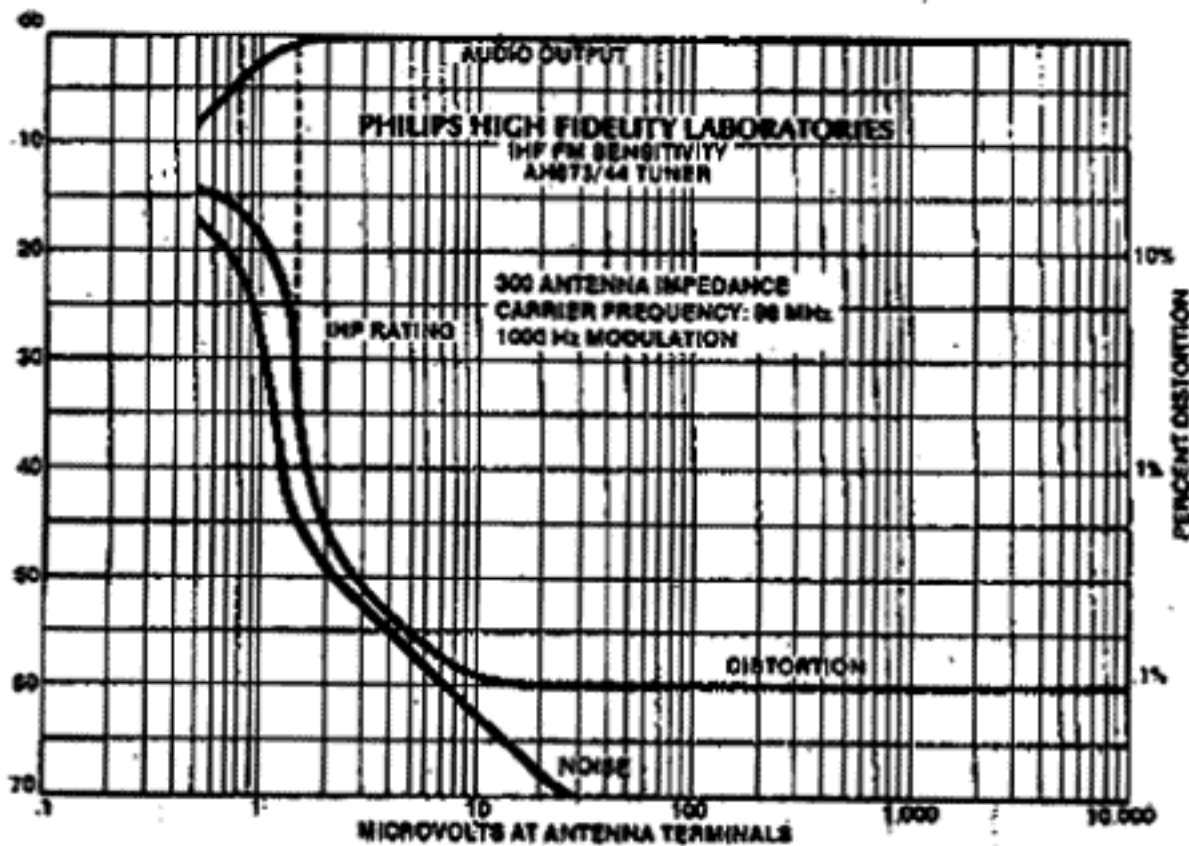
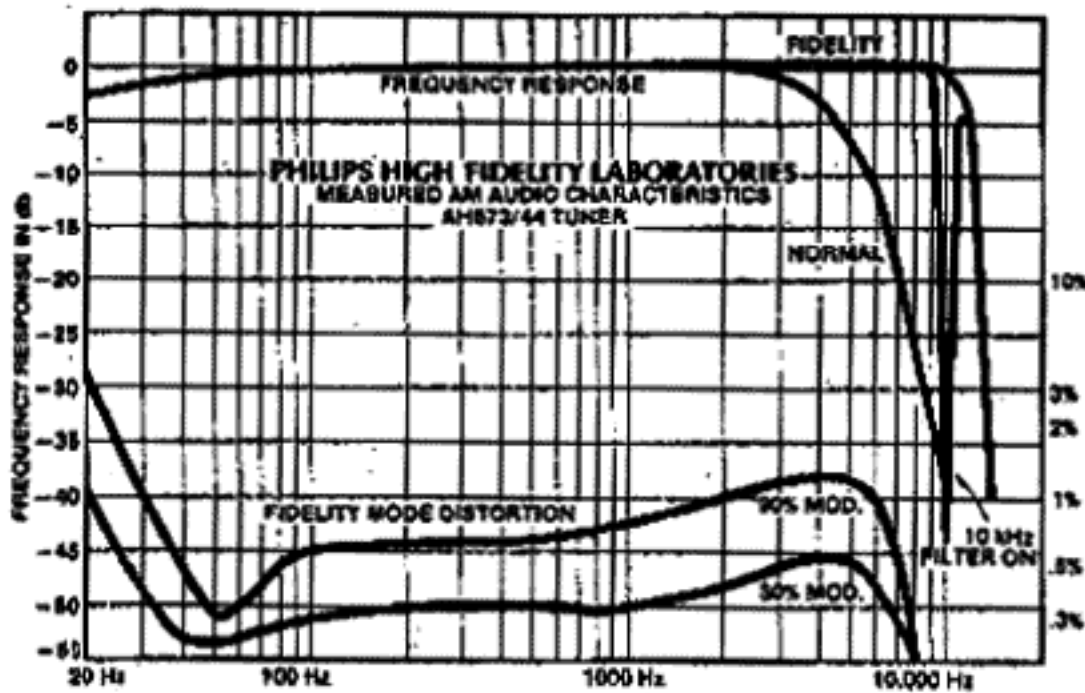

TECHNICAL SPECIFICATIONS

(Data subject to modification without notice)

FM SECTION

| | |
|--|---------------------------------------|
| Tuning Range | 87.5 – 108 MHz |
| Antenna Input | 300 ohm Balanced 75 ohm Unbalanced |
| Usable Sensitivity | |
| Mono | 1.6 μ V |
| Stereo | 3.0 μ V |
| 50 dB Quieting Sensitivity | |
| Mono | 2.5 μ V |
| Stereo | 32 μ V |
| Total Harmonic Distortion | |
| Mono | 0.09% |
| Stereo | 0.1% |
| Capture Ratio | 1.0 dB |
| AM Rejection | 50 dB |
| IF Rejection | 110 dB |
| Image Rejection | 110 dB |
| Spurious Response | 110 dB |
| Selectivity | |
| (Single Generator) | > 110 dB |
| (Dual Generator) | 83 dB |
| Pilot Carrier Suppression | 65 dB |
| Frequency Response (+ .5-1.5 dB) | 20-15 kHz |
| Stereo Separation | |
| 100 kHz | 45 dB |
| 1 kHz | 47 dB |
| 10 kHz | 38 dB |
| Hum and Noise (65 dBf and 100% modulation) | 75 dB |
| Muting Threshold | Adjust to 2 to 20 μ V |
| Audio Output (600 ohm and 47k Load, 100% Modulation) | 1.0 Volt |

AM SECTION

| | |
|-------------------------------------|---------------|
| Tuning Range | 540-1600 kHz |
| Sensitivity (normal AM) | |
| Long Wire | 20 μ V |
| Rod Antenna | 200 μ V/m |
| 3 dB AGC Level | 200 μ V/m |
| Selectivity | |
| Normal AM (Adjacent Ch.) | 40 dB |
| Full Fidelity (Alt. Ch.) | 40 dB |
| Image Rejection (Normal AM) | 65 dB @ 1 MHz |
| IF Rejection (Normal AM) | 50 dB @ 1 MHz |
| Harmonic Distortion (Full Fidelity) | |
| 30% Modulation | 0.5% |
| 90% Modulation | 1.5% |
| Frequency Response \pm 2 dB | |
| Normal AM | 20-3 kHz |
| Full Fidelity | 20-10 kHz |
| Hum and Noise (50 μ V/m) | 60 dB |
| 100% Modulation | |